

Schalt-Federkontakt 160 mil / 4.0 mm - Schalhub 4.0 mm

HIGHLIGHTS

Schalt-Federkontakt für die Kabelbaumprüfung und Bauteilabfrage

Steck- und Gewindesystem verfügbar

Schalhub 4.0 mm

Hohe Löttemperatur bis 300°C

MECHANISCHE DATEN

Rastermaß	4.00 mm/160 mil
Temperaturbereich	-30 °C - +120 °C
Maximaler Hub	5.00 mm
Arbeitshub	4.00 mm
Schalhub	4.00 mm
Federvorspannung	0.12/ 0.30/ 1.80/ 1.70/ 2.70/ 5.00 N
Federkraft bei Arbeitshub	0.25/ 1.30/ 6.00/ 8.00/ 9.00/ 12.00 N
Federkraft bei Schalhub	0.25/ 1.30/ 6.00/ 8.00/ 9.00/ 12.00 N

ELEKTRISCHE WERTE

Hülse Kolben

Max. Strombelastung	5.0 A
Typischer Durchgangswiderstand	<= 15 mOhm

Pin-Kolben

Max. Strombelastung	1.0 A
Typischer Durchgangswiderstand	<= 50 mOhm
Typische Isolationsspannung	1000 V

WERKSTOFFE

Gehäuse	Messing, vergoldet
Feder	Federstahl, vergoldet
Kolben	Stahl
Hülse	Messing, vergoldet

EMPF. BOHRER - DURCHMESSER

HP 2361.1 (Trolitax)	3.28 mm
HGW 2372 (Hartglasgewebe)	3.29 mm

VERFÜGBARE SCHRAUBWERKZEUGE

Artikelbezeichnung	max. Kopfdurchmesser
WFSB 1060/G-4.0-3.0	3.0
WFSB 1060/G-5.0-4.0-Z	4.0
WFSB 1060/G-6.0-5.0-Z	5.0



Technische Daten // Serie 3010/2G • 3010/10G

Schalt-Federkontakt 160 mil / 4.0 mm - Schalhub 4.0 mm

TASTKOPFFORM - DURCHMESSER - OBERFLÄCHE

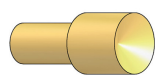

A
2.30 Au



C
1.80 Au

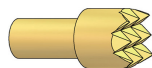

C
2.30 Au
3.00 Au
4.00 Au

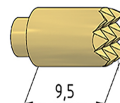

CL
2.30 Au

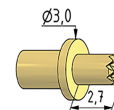

C1
1.00 Au

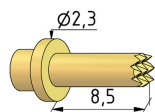

CL1
1.00 Au



CL2
1.80 Au

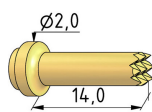

CL3
1.00 Au

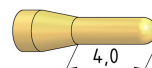

D6
1.00 Au



F
1.80 Au

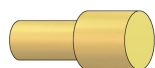

F
2.00 Au
2.30 Au



F1
2.30 HTK
3.00 HTK
4.00 HTK
5.00 HTK

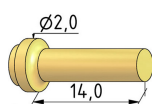

FL3
1.00 Au

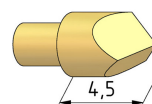

H2
2.60 Au

Anschlusspin-Ø X/mm	Anschlusspinlänge Y/mm
0.5	6.0
1.0	2.5
1.0	4.0

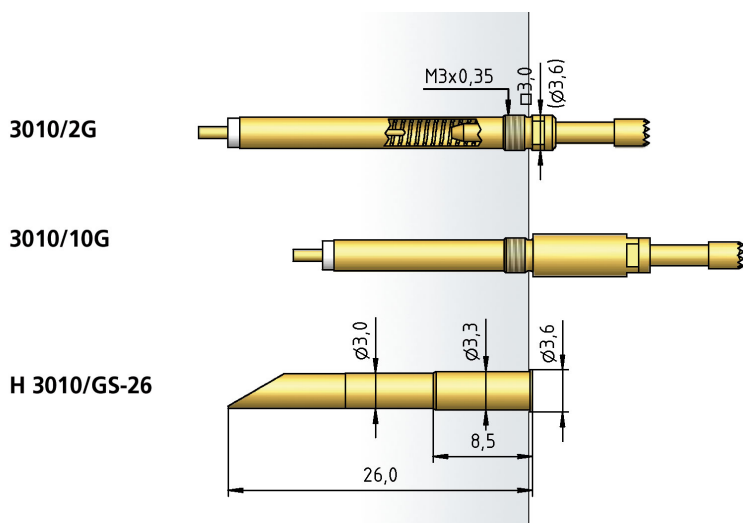



PTR HARTMANN

A Phoenix Mecano Company

Technische Daten // Serie 3010/2G • 3010/10G

Schalt-Federkontakt 160 mil / 4.0 mm - Schalhub 4.0 mm

BESTELLBEISPIEL

3010/ 2 G - A - 2.3 N - Au - 2.3 /1.0x 4.0 /SH4.0

1 2 3 4 5 6 7 8 9 10

- 1. Serie 2. Kragenhöhe 3. Gewindeausführung
- 4. Kopfform 5. Federkraft 6. Tastkopfveredelung
- 7. Kopfdurchmesser 8. Anschlusspindurchmesser
- 9. Anschlusspinlänge 10. Schalhub