



Teknik Veriler // Seri 1025/E

ICT-Test Probu 100 mil / 2.54 mm

Öne Çıkanlar

100 mil uygulamaları için uluslararası standart

Monte edilmiş PCB'lerin teması

Geniş kafa stili seçimi

MEKANİK VERİ

merkez	2,54 mm/100 mil
Sıcaklık aralığı	-30 °C - +120 °C
Tam seyahat	6,40 mm
Çalışma seyahati	4.30 mm
Önceden yüklenmiş yay kuvveti	0,20/ 0,25/ 0,40/ 0,60/ 0,50/ 0,80/ 1,40 K
Çalışma yolculuğunda yay kuvveti	0.60/ 1.00/ 1.50/ 2.00/ 2.25/ 3.00/ 4.00 K

ELEKTRİKSEL VERİ

Maks. Güncel Beğeni	5.0...8.0 A
Tipik süreklilik direnci	<= 20 mOhm

MALZEMELER

Varil	Bronz, altın kaplama
Bahar	Yay Çeliği, altın kaplama
piston	Çelik, Küp
priz	Bronz, altın kaplama

ÖNERİLEN MATKAP ÇAPI

HP 2361.1 (trolitaks)	1,65 mm
Preslenmiş halka ile	1,75 mm
HGW 2372 (cam dolgulu malzeme)	1,67 mm
Preslenmiş halka ile	1,76 mm

Teknik Veriler // **Seri 1025/E**

ICT-Test Probu 100 mil / 2.54 mm

UÇ STİLİ - ÇAP - KAPLAMA

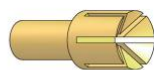

A

1.50C Au
2.00C Au

A6

1.50 Au
1.80C Au

B

0.90 Au



BD

0.90 Au



BST1

0,62 Au
0,62 Ni

BST2

0.90 Au



BST3

1.60C Au

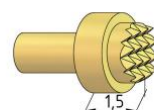

C

1.30 Avu
1.50C Au
2.00C Au
2.50C Au
3.00C Au

C1

2.30/3.10C Au

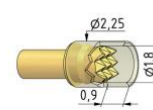

CS1

1.80/2.25C Au/HTK

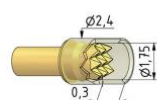

CS3

1.75/2.40C Au/HTK

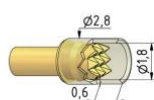

CS8

1.80/2.80C Au/HTK

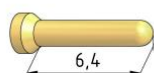

D1

0,50 Au
0,64C Au

D

0.90C Au



D

1.30 Avu
1.50 Au

E

1.50 Au



F

0.90 Au



F

1.50C Au



G

1.06 Au
1.30 Avu
1.50 Au

H

0.90 Au

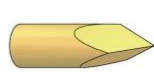

H

1.50 Au
1.70 Au
2.50 Au

H1

0.90 Au



HL2

0.90C Au



K

1.70 Au



M

1.30 Avu



M1

1.30 Au
1.40 Au
1.50 Au

M6

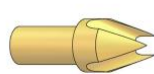
1.30 Avu
1.50 Au

N

0,50 Au



Q

0,50 Au
0,80 Au

Q

1.06 Au
1.30 Avu
1.50 Au

Teknik Veriler // Seri 1025/E

ICT-Test Probu 100 mil / 2.54 mm

UÇ STİLİ - ÇAP - KAPLAMA

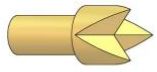

S5

1.06 Au

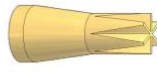

Q6F

0.64C Au



Q8

1.50 Au



Q8F

0.90C Au



QL2

1.50 Au

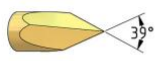

V

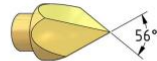
0.90 Au
0.90 Ni

V

1.30 Avu

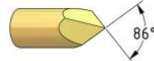

V1

0.90 Au



V3

0.90 Au



V5

0.90 Au

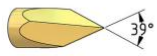

VL2

0.90 Au

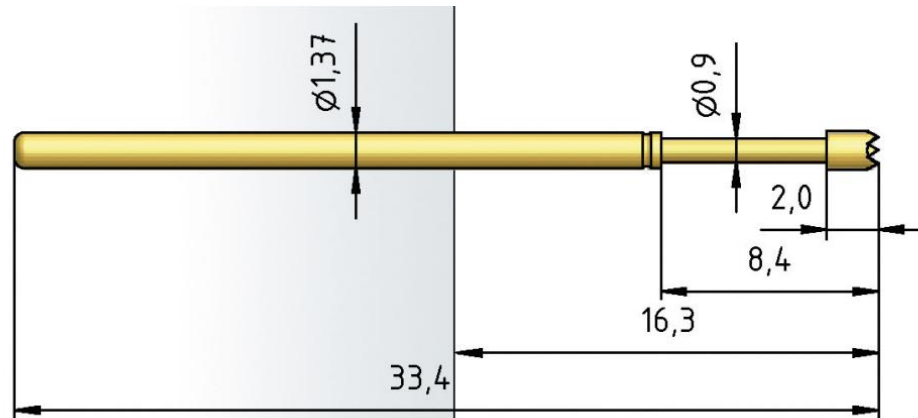
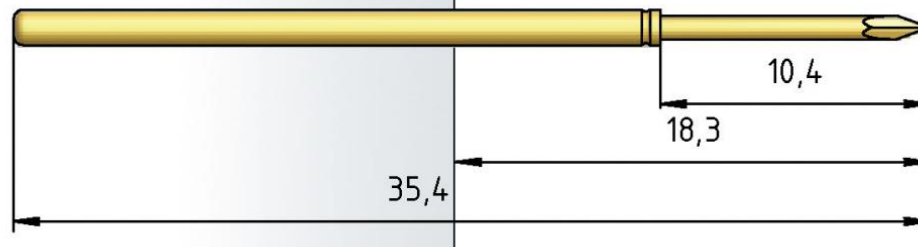
1025/E

1025/E (for Tip Styles HL2 / QL2 / VL2)

ICT-Test Probu 100 mil / 2.54 mm

Prizler 1025/E

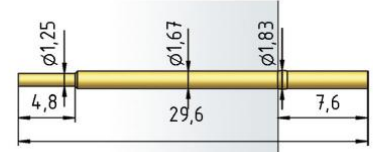
H 1025 C



H 1025 L



H 1025 W



H 1025 WR



H 1025 W18



H 1025 C-K

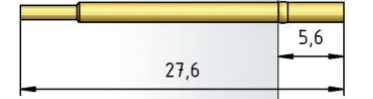

H 1025 L-K



H 1025 W-K



H 1025/2C

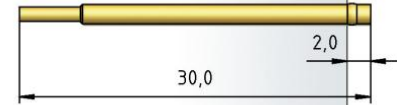

H 1025/2 L



H 1025/2 W



H 1025/12C

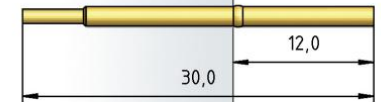

H 1025/12 L

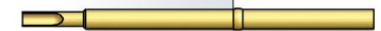

H 1025/12 W



BGK 1025

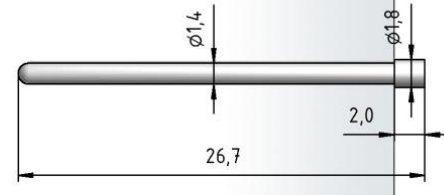

NASIL SİPARİŞ VERİLİR

1025/E - C - 1.5 N - Au - 1.5 C

1 2 3 4 5 6

1. Seri 2. Uç Stili 3. Yay Kuşveti 4. Uç
Kaplama 5. Uç Çapı 6. Uç Malzemesi (sadece CuBe için)