



Teknik Veriler // Seri 3010/2GW • 3010/2GW5

PTR HARTMANN

A Phoenix Mecano Company

Kolay Değiştirilebilir Sistemli Anahtarlama Testi Probu 160 mil / 4.0 mm - Anahtarlama Hareketi 4.0 mm

Öne Çıkanlar

Kablo demeti testi ve varlık doğrulaması için anahtarlama işlevli Test Probu

Dişli tip

Kolay değiştirme sistemi (lehimsiz değiştirme)

Anahtarlama hareketi 4.0 mm

300°C'ye kadar yüksek lehimleme sıcaklığı

Değişken uzatma yüksekliği

MEKANİK VERİ

merkez	4,00 mm/160 mil
Sıcaklık aralığı	-30 °C - +120 °C
Tam seyahat	5,00 mm
Çalışma seyahati	4,00 mm
Seyahat değiştirme	4,00 mm
Önceden yüklenmiş yay kuvveti	0.12/ 0.25/ 0.30/ 0.40/ 0.60/ 1.40/ 1.70/ 1.80/ 2.00/ 2.70/ 2.00/ 5.00/ 4.00 N
Çalışma yolculuğunda yay kuvveti	0.25/ 0.75/ 1.30/ 1.80/ 3.00/ 6.00/ 6.50/ 8.00/ 8.50/ 9.00/ 9.50/ 12.00/ 12.50 K
Anahtarlama hareketinde yay kuvveti	0.25/ 0.75/ 1.30/ 1.80/ 3.00/ 6.00/ 6.50/ 8.00/ 8.50/ 9.00/ 9.50/ 12.00/ 12.50 K

ELEKTRİKSEL VERİ

Priz-Piston	
Maks. Güncel Beğeni	5.0 A
Tipik süreklilik direnci	<= 15 mOhm
Pim-Pistonu	
Maks. Güncel Beğeni	1.0 A
Tipik süreklilik direnci	<= 50 mOhm
Tipik izolasyon gerilimi	1000 V

MALZEMELER

Varil	Pirinç, altın kaplama
Bahar	Yay Çeliği, altın kaplama
piston	Çelik
priz	Pirinç, altın kaplama

ÖNERİLEN MATKAP ÇAPLARI

Y 3010/GW(5)	
HP 2361.1 (trolitaks)	3.28 mm
HGW 2372 (cam dolgulu malzeme)	3.29 mm
H 3010/GWR5	
HP 2361.1 (trolitaks)	3.31 mm
HGW 2372 (cam dolgulu malzeme)	3.32 mm

Teknik Veriler // Seri 3010/2GW • 3010/2GW5

Kolay Değişirilebilir Sistemli Anahtarlama Testi Probu 160 mil / 4.0 mm - Anahtarlama Hareketi 4.0 mm

UÇ STİLİ - ÇAP - KAPLAMA



A

2.30 Au



C

1.80 Au

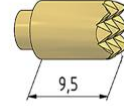

C

 2.30 Au
 3.00 Au
 4.00 Au

CL

2.30 Au

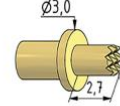

C1

1.00 Au

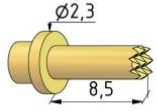

CL1

1.00 Au



CL2

1.80 Au

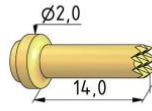

CL3

1.00 Au

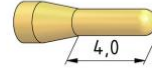

D6

1.00 Au



F

1.80 Au

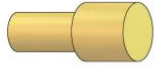

F

 2.00 Au
 2.30 Au

F1

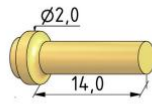
 2.30 HTK
 3.00 HTK
 4.00 HTK
 5.00 HTK

FL3

1.00 Au

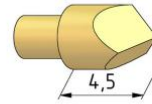

H2

2.60 Au

Kolay Değişirilebilir Sistemli Anahtarlama Testi Probu 160 mil / 4.0 mm - Anahtarlama Hareketi 4.0 mm

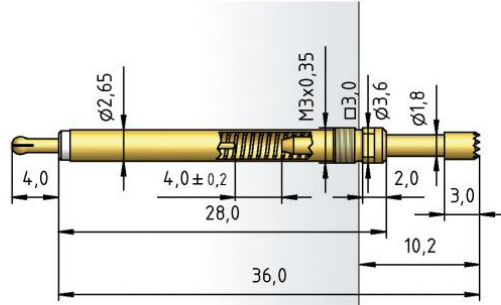
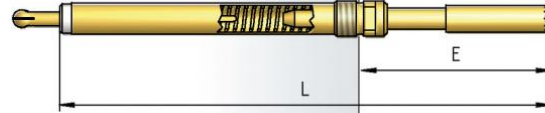
3010/2GW**3010/2GW**
(for
Tip Styles
CLx / FLx)

Typ style	E	L
CL, CL1	16,7	42,5
CL2	22,2	48,0
CL3, FL3	22,9	48,7

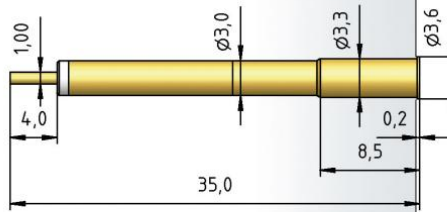
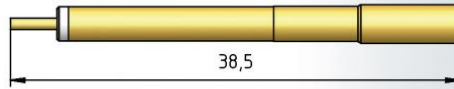
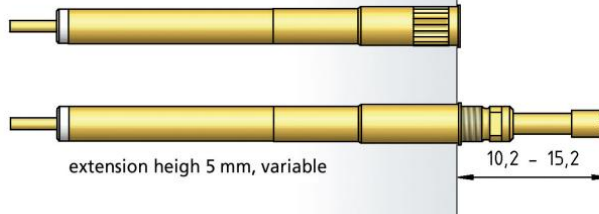
H 3010/GW**3010/2GW5****H 3010/GW5****H 3010/GWR5****NASIL SİPARİŞ VERİLİR**

3010/ 2 GW 5 - C - 1.3 N - Au - 2.3 /SH4.0

1 2 3 4 5 6 7 8 9 10

1. Seri 2. Yaka Yüksekliği 3. Dişli Tasarı m 4.
Lehimsiz Değişirilebilir 5. Ayar Alanı
Uzatma Yüksekliği
6. Uç Stili 7. Yay Kuvveti 8. Uç Kaplama 9.
Uç Çapı 10. Geçiş Hareketi